

- Forged or casted body and bonnet
- Pressure seal design
- Rising stem (RS), outside screw and yoke (OS&Y)
- Split wedge type obturator
- Seating surfaces made from 17Cr or Stellite

APPLICATIONS:

- Power plant
- Chemical
- Petrochemical
- Refining
- Water supply and other



ADVANTAGES:

- Long service life
- Respect to emission standards
- Easy handling and maintenance
- Stem packing replacement in working conditions

TECHNICAL DATA:

Media:	Depending on the gate valves materials for: water, steam, gas, oil and other non-aggressive media
Pressure and temperature:	Pressures up to 400 bar Class 900 ÷ Class 2500 Temperature up to 600 °C
Materials:	Carbon, heat resistant alloys and stainless steel
Options:	Electric actuator Position indicator Extended stem Locking device Spring loaded stuffing box (SLSB) With hole in the wedge With bypass Valve With equalizing pipe and bypass valves Flanges and welding ends according to: ASME, DIN, EN, GOST, etc. Other paint finishes are available upon customer's request
Testing:	Every produced gate valve was tested according to API 598 or EN 12266

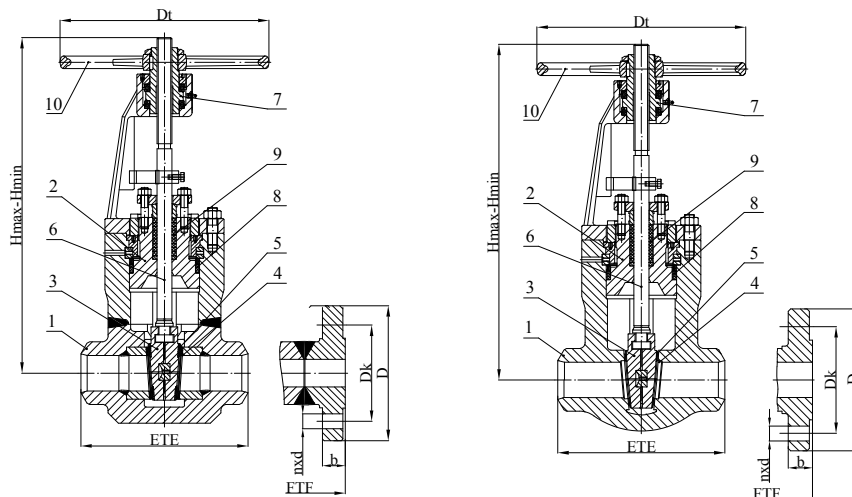

LIST OF MATERIALS:

Item	Čast'	Material Group acc. to EN 12516-1 (ASME B16.34)				
		3E0 (1.1)	4E0 (1.5 a 1.3)	5E0 (1.17 1.9)	6E0 (1.10)	9E1 / 1C15 (1.15)
		Using				
		up to 400 °C (-29 °C ÷ 425 °C)	up to 550 °C (-29 °C ÷ 470 °C)	up to 550 °C (-29 °C ÷ 595 °C)	up to 600 °C (-29 °C ÷ 595 °C)	up to 600 °C (-29 °C ÷ 600 °C)
1	Body ¹⁾	1.0460 / 1.0619 (A105 / WCB)	1.5415 / 1.5419 (F1 / WC1)	1.7335 / 1.7357 (F11 Cl.2 / WC6)	1.7383 / 1.7379 (F11 Cl.3 / WC9)	1.4903 / C12A (F91 / C12A)
2	Bonnet ¹⁾	1.0460 / 1.0619 (A105 / WCB)	1.5415 / 1.5419 (F1 / WC1)	1.7335 / 1.7357 (F11 Cl.2 / WC6)	1.7383 / 1.7379 (F11 Cl.3 / WC9)	1.4903 / C12A (F91 / C12A)
3	Disc ¹⁾	1.0460 / 1.0619 (A105 / WCB)	1.5415 / 1.5419 (F1 / WC1)	1.7335 / 1.7357 (F11 Cl.2 / WC6)	1.7383 / 1.7379 (F11 Cl.3 / WC9)	1.4903 / C12A (F91 / C12A)
4	Body welded on with	17 Cr (up to 450 °C) or Stellite				
5	Wedge welded on with	17 Cr (up to 450 °C) or Stellite				
6	Stem	1.4021 / 1.4122				
7	Stem nut	1,0715 / 1,07225 / Cu alloy				
8	Bonnet Gasket	graphite with corrosion inhibitor				
9	Stem Packing	graphite with corrosion inhibitor				
10	Handwheel	Cast iron				

1) other materials available according to ASTM standards

STANDARTS:

High Pressure Gate Valves	Class 1500 ÷ Class 2500 and PN 250 ÷ PN 400
Face-to face dimensions according to	ASME B16.10 and Manufacturer standard
Flanged ends according to	ASME B16.5 or EN 1092-1
Welding ends according to	ASME B16.25 or EN 1092-1

[GHP] DIMENSIONS CLASS 1500 - CAST BODY

DN		50	65	80	100	125	150	200	250	300
[mm]	ETE	216	254	305	406	483	559	711	864	991
	FTF	368	419	470	546	673	705	832	991	1130
	D	215	245	265	310	375	395	485	585	675
	Dk	165,1	190,5	203,2	241,3	292,1	317,5	393,7	482,6	571,5
	nxd	8×25,4	8×28,6	8×31,7	8×34,9	8×41,3	12×38,1	12×44,5	12×50,8	16×54,0
	b	45,1	48,3	47,7	61,0	80,1	89,6	99,1	115,0	130,9
	Hmax	540	700	835	920	1170	1515	1720 ⁽⁴⁾	2 355 ⁽⁴⁾	2 650 ⁽⁴⁾
	Hmin	480	622	735	805	1 030	1 340	1 500 ⁽⁴⁾	2 080 ⁽⁴⁾	2 300 ⁽⁴⁾
	Dt	315	315	400	500	500	500	400 ⁽³⁾	500 ⁽³⁾	500 ⁽³⁾
	kg	ETE	47	57	66	123	197	312	690	1380
	FTF	65	82	100	170	285	420	880	1700	2100

[GHP] DIMENSIONS CLASS 2500 - CAST BODY

DN		50	65	80	100	125	150	200	250	300
[mm]	ETE	279	330	368	457	533	610	762	914	1 041
	FTF	451	508	578	673	794	914	1 022	1 270	⁽⁵⁾
	D	235	265	305	355	420	485	550	675	760
	Dk	171,4	196,8	228,6	273,0	323,8	368,3	438,2	539,8	619,1
	nxd	8×28,6	8×31,8	8×34,9	8×41,3	8×47,1	8×54,0	12×54,0	12×66,7	12×73,0
	b	57,9	64,2	73,7	83,2	99,1	115,0	134,0	172,1	191,2
	Hmax	540	700	835	920	1 170	1 515	1 720 ⁽⁴⁾	2 355 ⁽⁴⁾	2 650 ⁽⁴⁾
	Hmin	480	622	735	805	1 030	1 340	1 500 ⁽⁴⁾	2 080 ⁽⁴⁾	2 300 ⁽⁴⁾
	Dt	315	400	500	500	500	630	630 ⁽³⁾	630 ⁽³⁾	630 ⁽³⁾
kg	ETE	63	85	94	265	275	346	750	1 260	1 720
	FTF	90	120	160	360	442	611	1 100	2 010	⁽⁵⁾

[GHP] DIMENSIONS PN 250 FORGED BODY

DN		15	20	25	32	40	50	65	80	100	125	150	200	250	300
[mm]	ETE	90	114	140	165	178	250	300	350	400	450	500	600	700	800
	FTF	180	210	240	250	270	300	360	390	450	525	600	750	900	1 050
	D	130	-	150	-	185	200	230	255	300	340	390	485	585	690
	Dk	90	-	105	-	135	150	180	200	235	275	320	400	490	590
	nxd	4×18	-	4×22	-	4×26	8×26	8×26	8×30	8×33	12×33	12×36	12×42	16×48	16×52
	b	26	-	28	-	34	38	42	46	54	60	68	82	100	120
	Hmax	181	203	267	297	297	540	700	835	920	1 170	1 515	1 720 ⁽⁴⁾	2 355 ⁽⁴⁾	2 650 ⁽⁴⁾
	Hmin	165	183	237	255	255	480	622	735	805	1 030	1 340	1 500 ⁽⁴⁾	2 080 ⁽⁴⁾	2 300 ⁽⁴⁾
	Dt	100	120	150	150	150	315	400	500	500	500	630	500 ⁽³⁾	500 ⁽³⁾	500 ⁽³⁾
kg	ETE	2,6	4,1	8	13	14	95	165	190	350	420	580	845	1 750	2 320
	FTF	5,8	6,5	11,2	20	24	113	196	230	300	510	685	1 030	2 150	2 800

[GHP] DIMENSIONS PN 320 FORGED BODY

DN		15	20	25	32	40	50	65	80	100	125	150	200	250	300
[mm]	ETE	114	148	180	232	232	250	300	350	400	450	500	600	700	800
	FTF	220	⁽²⁾	280	⁽²⁾	310	350	425	470	550	650	750	950	1 150	⁽⁵⁾
	D	130	-	160	-	195	210	255	275	335	380	425	525	640	-
	Dk	90	-	115	-	145	160	200	220	265	310	350	440	540	-
	nxd	4×18	-	4×22	-	4×26	8×26	8×30	8×30	8×36	12×36	12×39	16×42	16×52	-
	b	26	-	34	-	38	42	51	55	65	75	84	103	125	-
	Hmax	203	270	297	349	349	540	700	835	920	1 170	1 515	1 720 ⁽⁴⁾	2 355 ⁽⁴⁾	2 650 ⁽⁴⁾
	Hmin	183	237	255	313	313	480	622	735	805	1 030	1 340	1 500 ⁽⁴⁾	2 080 ⁽⁴⁾	2 300 ⁽⁴⁾
	Dt	120	150	150	250	250	315	400	500	500	500	630	630 ⁽³⁾	630 ⁽³⁾	630 ⁽³⁾
kg	ETE	4,1	8,2	11,5	18	18	95	165	190	350	420	580	845	1 750	2 320
	FTF	8,5	⁽²⁾	19	⁽²⁾	34	115	193	235	425	535	736	1 155	2 370	⁽⁵⁾

[GHP] DIMENSIONS PN 400 FORGED BODY

DN		15	20	25	32	40	50	65	80	100	125	150	200	250	300
[mm]	ETE	114	148	180	232	232	250	300	350	400	450	500	600	700	800
	FTF	220	⁽²⁾	280	⁽²⁾	310	350	425	470	550	650	750	950	⁽⁵⁾	⁽⁵⁾
	D	145	-	180	-	220	235	290	305	370	415	475	585	-	-
	Dk	100	-	130	-	165	180	225	240	295	340	390	490	-	-
	nxd	4×22	-	4×26	-	4×30	8×30	8×33	8×33	8×39	12×39	12×42	16×48	-	-
	b	30	-	38	-	48	52	64	68	80	92	105	130	-	-
	Hmax	203	270	297	349	349	540	700	835	920	1 170	1 515	1 720 ⁽⁴⁾	2 355 ⁽⁴⁾	2 650 ⁽⁴⁾
	Hmin	183	237	255	313	313	480	622	735	805	1 030	1 340	1 500 ⁽⁴⁾	2 080 ⁽⁴⁾	2 300 ⁽⁴⁾
	Dt	120	150	150	250	250	315	400	500	500	500	630	630 ⁽³⁾	630 ⁽³⁾	630 ⁽³⁾
kg	ETE	9,5	⁽²⁾	20	⁽²⁾	35	125	200	250	450	590	850	1 260	⁽⁵⁾	⁽⁵⁾
	FTF	4,1	8,2	11,5	18	18	95	165	190	350	420	580	845	1 750	2 320

(2) Flange dimensions are not defined according to EN 1092-1

(3) Gearbox operated

(4) Height without actuator

(5) On request

RANGE OF APPLICATION

		Pressure (bar) / temperature (°C) ratings according to EN 12516-1																					
materials	PN	-10	20	50	100	150	200	250	300	350	375	400	425	450	470	475	480	500	510	525	550	575	600
1.0460 1.0619	250	250,0	250,0	250,0	243,1	222,1	210,1	192,1	174,0	162,0	156,0	150,0											
	320	320,0	320,0	320,0	299,7	284,3	268,9	245,9	222,8	207,5	199,8	192,1											
	400	400,0	400,0	400,0	374,5	355,3	336,1	307,3	278,5	259,3	249,7	240,1											
1.5415 1.5419	250	250,0	250,0	250,0	250,0	244,6	228,1	213,1	198,1	186,1	183,1	180,1	173,5	166,8	164,4	163,8	163,2	113,4	98,7	70,7	40,0		
	320	320,0	320,0	320,0	320,0	313,1	292,0	272,8	253,6	238,2	234,3	230,5	222,1	213,6	210,5	209,8	209,0	145,1	126,4	90,5	51,2		
	400	400,0	400,0	400,0	400,0	391,3	364,9	340,9	316,9	297,7	292,9	288,1	277,5	267,0	263,1	262,2	261,2	181,4	157,9	113,1	64,0		
1.7335 1.7357	250	250,0	250,0	250,0	250,0	250,0	250,0	250,0	250,0	232,9	224,5	213,4	204,1	197,2	187,2	184,7	180,7	156,0	139,5	114,7	73,4		
	320	320,0	320,0	320,0	320,0	320,0	320,0	320,0	320,0	298,1	287,4	273,4	261,3	252,5	239,7	236,5	231,3	199,8	178,6	146,8	93,9		
	400	400,0	400,0	400,0	400,0	400,0	400,0	400,0	400,0	372,6	359,2	341,4	326,6	315,6	299,5	295,5	289,1	249,7	223,2	183,5	117,4		
1.7383 1.7379	250	250,0	250,0	250,0	250,0	250,0	250,0	250,0	250,0	234,7	226,3	213,4	204,1	197,2	187,2	184,7	180,7	164,5	158,9	134,7	88,0	86,0	37,3
	320	320,0	320,0	320,0	320,0	320,0	320,0	320,0	320,0	300,4	289,7	273,2	261,3	252,5	39,7	236,5	231,3	210,7	203,4	172,5	112,7	110,1	47,8
	400	400,0	400,0	400,0	400,0	400,0	400,0	400,0	400,0	375,5	362,1	341,4	326,6	315,6	299,5	295,5	289,1	263,3	254,3	215,5	140,9	137,6	59,8
1.4903	250	250,0	250,0	250,0	250,0	250,0	250,0	250,0	250,0	234,7	226,3	213,4	204,1	197,2	187,2	184,7	180,7	164,5	158,9	150,4	145,6	139,7	125,0
	320	320,0	320,0	320,0	320,0	320,0	320,0	320,0	320,0	300,4	289,7	273,2	261,3	252,5	239,7	236,5	231,3	210,7	203,4	192,6	186,4	178,8	160,1
	400	400,0	400,0	400,0	400,0	400,0	400,0	400,0	400,0	375,5	362,1	341,4	326,6	315,6	299,5	295,5	289,1	263,3	254,3	240,7	232,9	223,5	200,1
A217 C12A	250	250,0	250,0	250,0	250,0	250,0	250,0	250,0	241,2	223,1	215,1	209,5	202,0	190,4	182,2	176,0	164,9	146,9	142,6	136,1	129,9	124,7	101,6
	320	320,0	320,0	320,0	320,0	320,0	320,0	320,0	308,8	285,6	275,4	268,2	258,6	243,8	233,2	225,4	211,0	188,0	182,5	174,2	166,3	159,6	130,0
	400	400,0	400,0	400,0	400,0	400,0	400,0	400,0	386,0	357,0	344,2	335,1	323,2	304,7	291,5	281,7	263,8	235,0	228,1	217,8	207,9	199,5	162,5

		Pressure (bar) / temperature (°C) ratings according to ANSI B16.34																				
materials	PN	-29 +38	50	100	150	200	250	300	325	350	375	400	425	450	475	500	538	550	575	600		
A 105 WCB	1500	255,3	250,6	233,0	225,4	219,1	209,7	199,1	193,6	187,8	181,8	173,6	143,8	115,0	87,2	58,8	29,5					
	2500	425,5	417,7	388,3	375,6	365,0	349,5	331,8	322,6	313,0	303,1	389,3	239,7	191,7	145,3	97,9	49,2					
WC1	1500	240,1	237,3	226,7	219,7	212,7	203,9	193,4	187,9	182,0	174,9	163,1	136,5	107,9	78,3	55,4	29,5					
	2500	400,1	395,6	377,8	366,1	354,4	339,8	322,4	313,1	303,3	291,4	271,9	227,5	179,9	130,6	92,3	49,2					
F1	1500	240,1	240,1	239,7	236,7	229,0	222,5	214,4	206,6	201,1	194,1	183,1	175,1	169,0	158,2	120,3	56,7					
	2500	400,1	400,1	399,5	394,5	381,7	370,9	357,1	344,3	335,3	323,2	304,9	291,6	281,8	263,9	200,5	94,6					
WC6	1500	258,6	258,6	257,4	248,7	239,8	231,8	214,4	206,6	201,1	194,1	183,1	175,1	169,0	158,2	128,6	74,5	63,5	44,0	30,5		
	2500	430,9	430,9	429,0	414,5	399,6	386,2	357,1	344,3	335,3	323,2	304,9	291,6	281,8	263,9	214,4	124,1	105,9	73,4	50,9		
F12 CI.2	1500	258,6	257,5	252,2	240,9	231,3	224,1	214,4	206,6	201,1	194,1	183,1	175,1	169,0	139,3	106,9	68,6	60,2	44,0	30,3		
	2500	430,9	429,2	420,4	401,5	385,6	373,5	357,1	344,3	335,3	323,2	304,9	291,6	281,8	232,1	178,2	114,3	100,4	73,4	50,4		
F22 CI.3 WC9	1500	258,6	258,6	257,6	250,8	243,4	231,8	214,4	206,6	201,1	194,1	183,1	175,1	169,0	158,2	140,9	92,2	78,2	52,6	34,4		
	2500	430,9	430,9	429,4	418,2	405,4	386,2	375,1	344,3	335,3	323,2	304,9	291,6	281,8	263,9	235,0	153,7	130,3	87,7	57,4		
F91 C12A	1500	258,6	258,6	257,6	250,8	243,4	231,8	214,4	206,6	201,1	194,1	183,1	175,1	169,0	158,2	140,9	125,5	124,9	119,7	97,5		
	2500	430,9	430,9	429,4	418,2	405,4	386,2	357,1	344,3	335,3	323,2	304,9	291,6	281,8	263,9	235,0	208,9	208,0	199,5	162,5		

OPTIONAL EXECUTION

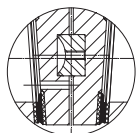

With hole in wedge

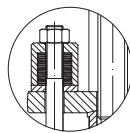

Spring loaded stuffing box (SLSB)

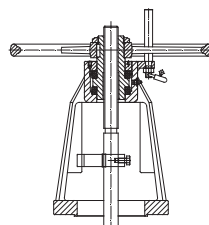

Locking device

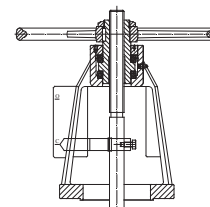

Position indicator

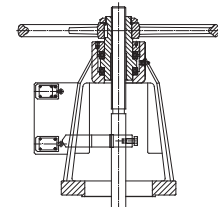

Limit switches

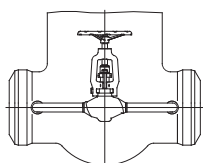

With bypass valve

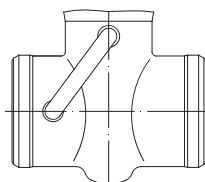

With equalizing pipe

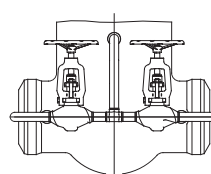

With equalizing pipe and bypass valves

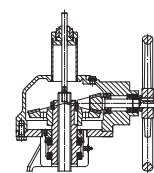
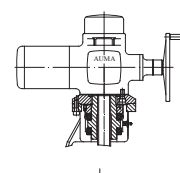

Operated by electric, hydraulic actuator or by gearbox

The data in this datasheet are informative only and the manufacturer reserves the right to changes of technical details.